



**EN** Operating instructions..... pages 1 to 8  
Translation of the original operating instructions

**FR** Vous trouverez la version actuelle du mode d'emploi dans votre langue nationale officielle sur l'Internet, [www.schmersal.net](http://www.schmersal.net).

**ES** Encontrará el manual de instrucciones actual en su idioma oficial de la UE en nuestra página de Internet [www.schmersal.net](http://www.schmersal.net).

**NL** U vindt de huidige versie van de gebruikshandleiding in uw officiële landstaal op het Internet, [www.schmersal.net](http://www.schmersal.net).

**IT** Il manuale d'istruzioni aggiornato nella vostra lingua (lingua ufficiale UE) è scaricabile in Internet all'indirizzo [www.schmersal.net](http://www.schmersal.net).

**JP** EU公用語で書かれた最新の取扱説明書は、インターネット([www.schmersal.net](http://www.schmersal.net))からダウンロードできます。

## Inhalt

<b>1 About this document</b>	
1.1 Function	1
1.2 Target group: authorised qualified personnel	1
1.3 Explanation of the symbols used	1
1.4 Appropriate use	1
1.5 General safety instructions	1
1.6 Warning about misuse	1
1.7 Exclusion of liability	2
<b>2 Product description</b>	
2.1 Ordering code	2
2.2 Special versions	2
2.3 Destination and use	2
2.4 Technical data	2
2.5 Safety classification	3
<b>3 Mounting</b>	
3.1 General mounting instructions	3
3.2 Dimensions	3
<b>4 Electrical connection</b>	
4.1 General information for electrical connection	3
<b>5 Operating principle and settings</b>	
5.1 LED functions	3
5.2 Description of the terminals	3
5.3 Set-up instructions	4
<b>6 Set-up and maintenance</b>	
6.1 Functional testing	4
6.2 Maintenance	4
<b>7 Disassembly and disposal</b>	
7.1 Disassembly	4
7.2 Disposal	4
<b>8 Appendix</b>	
8.1 Wiring examples	5
8.2 Sensor configuration	7
8.3 Actuator configuration	7
8.4 Flow diagram	7
8.5 EC Declaration of conformity	8

## 1 About this document

### 1.1 Function

This operating instructions manual provides all the information you need for the mounting, set-up and commissioning to ensure the safe operation and disassembly of the safety-monitoring module. The operating instructions must be available in a legible condition and a complete version in the vicinity of the device.

### 1.2 Target group: authorised qualified personnel

All operations described in this operating instructions manual must be carried out by trained specialist personnel, authorised by the plant operator only.

Please make sure that you have read and understood these operating instructions and that you know all applicable legislations regarding occupational safety and accident prevention prior to installation and putting the component into operation.

The machine builder must carefully select the harmonised standards to be complied with as well as other technical specifications for the selection, mounting and integration of the components.

### 1.3 Explanation of the symbols used



#### Information, hint, note:

This symbol is used for identifying useful additional information.



**Caution:** Failure to comply with this warning notice could lead to failures or malfunctions.

**Warning:** Failure to comply with this warning notice could lead to physical injury and/or damage to the machine.

### 1.4 Appropriate use

The products described in these operating instructions are developed to execute safety-related functions as part of an entire plant or machine. It is the responsibility of the manufacturer of a machine or plant to ensure the proper functionality of the entire machinery or plant.

The safety-monitoring module must be exclusively used in accordance with the versions listed below or for the applications authorised by the manufacturer. Detailed information regarding the range of applications can be found in the chapter "Product description".

### 1.5 General safety instructions

The user must observe the safety instructions in this operating instructions manual, the country-specific installation standards as well as all prevailing safety regulations and accident prevention rules.



Further technical information can be found in the Elan catalogues or in the online catalogue on the Internet: [www.schmersal.net](http://www.schmersal.net).

The information contained in this operating instructions manual is provided without liability and is subject to technical modifications.

There are no residual risks, provided that the safety instructions as well as the instructions regarding mounting, commissioning, operation and maintenance are observed.

### 1.6 Warning about misuse



In case of inadequate or improper use or manipulations of the safety-monitoring module, personal hazards or damage to machinery or plant components cannot be excluded. The relevant requirements of the standard EN 1088 must be observed.

### 1.7 Exclusion of liability

We shall accept no liability for damages and malfunctions resulting from defective mounting or failure to comply with this operating instructions manual. The manufacturer shall accept no liability for damages resulting from the use of unauthorised spare parts or accessories.

For safety reasons, invasive work on the device as well as arbitrary repairs, conversions and modifications to the device are strictly forbidden; the manufacturer shall accept no liability for damages resulting from such invasive work, arbitrary repairs, conversions and/or modifications to the device.

## 2 Product description

### 2.1 Ordering code

This operating instructions manual applies to the following types:

SRB 202MSK①		
No.	Option	Description
①		without cross-wire monitoring
	/QS	with cross-wire monitoring



Only if the information described in this operating instructions manual are realised correctly, the safety function and therefore the compliance with the Machinery Directive is maintained.

### 2.2 Special versions

For special versions, which are not listed in the order code below 2.1, these specifications apply accordingly, provided that they correspond to the standard version.

### 2.3 Destination and use

The safety-monitoring modules for integration in safety circuits are designed for fitting in control cabinets. They are used for the safe evaluation of the signals of positive-break position switches or semi-conductor sensors to initiate a muting function.

The safety function is defined as the opening of enabling circuits 13-14 and 23-24 when the inputs S11-S12 and/or S21-S22 are opened. The safety-relevant current paths with the output contacts 13-14 and 23-24 meet the following requirements under observation of a B<sub>10d</sub> value assessment (also refer to "Requirements to DIN EN ISO 13849-1"):

- Control category 4 PL e to DIN EN ISO 13849-1
- corresponds to SIL 3 to DIN EN 61508-2
- corresponds to SILCL 3 to DIN EN 62061 (corresponds to control category 4 to DIN EN 954-1)

To determine the Performance Level (PL) of the entire safety function (e.g. sensor, logic, actuator) to DIN EN ISO 13849-1, an analysis of all relevant components is required.

### 2.4 Technical data

General data:	
Standards:	IEC/EN 60204-1, EN 60947-5-1; EN ISO 13849-1, IEC/EN 61508, DIN EN 61496-1 part A.7.4
Climate resistance:	EN 60068-2-78
Fixing:	Snaps onto standard DIN rails to DIN EN 60715
Terminal designations:	EN 60947-1
Material of the enclosure:	glass-fibre reinforced thermoplastic, ventilated
Material of the contacts:	AgSnO, AgNi, self-cleaning, positive drive
Weight:	350 g
Start conditions	by external muting sensors
Feedback circuit (Y/N):	Yes
Pull-in delay:	typ. 200 ms
Drop-out delay in case of emergency stop:	typ. 20 ms
Drop-out delay on "supply failure":	typ. 60 ms
Time difference muting sensors:	typ. 2.5 sec
Mechanical data:	
Connection type:	Screw terminals
Cable section:	min. 2 mm <sup>2</sup> / max. 2 mm <sup>2</sup>
Connecting cable:	rigid or flexible
Tightening torque for the terminals:	0.6 Nm
With removable terminals (Y/N):	Yes
Mechanical life:	10 million operations
Electrical life:	Derating curve available on request
Resistance to shock:	10 g / 11 ms
Resistance to vibrations to EN 60068-2-6:	10 ... 55 Hz, amplitude 0.35 mm
Ambient conditions:	
Ambient temperature:	–25°C ... +45°C
Storage and transport temperature:	–40°C ... +85°C
Protection class:	Enclosure: IP 40 Terminals: IP 20 Wiring compartment: IP 54
Air clearances and creepage distances to IEC/EN 60664-1:	4 kV/2 (basic insulation)
EMC rating:	to EMC Directive
Electrical data:	
Contact resistance in new state:	max. 100 mΩ
Power consumption:	max. 3.1 W plus signalling outputs and muting indicators
Rated operating voltage U <sub>e</sub> :	24 VDC –15%/+20%, residual ripple max. 10%
Max. fuse rating of the operating voltage:	F1: internal electronic fuse, tripping current > 1.25 A, reset after approx. 1 sec.
Monitored inputs:	
Cross-wire detection (Y/N):	No QS variant: yes
Wire breakage detection (Y/N):	Yes
Earth leakage detection (Y/N):	Yes
Number of NO contacts:	0
Number of NC contacts:	2
Cable lengths:	1,500 m with 1.5 mm <sup>2</sup> 2,500 m with 2.5 mm <sup>2</sup>
Conduction resistance:	max. 40 Ω
Outputs:	
Number of safety contacts:	2
Number of auxiliary contacts:	0
Number of signalling outputs:	3
Switching capacity of the safety contacts:	<b>13-14 / 23-24:</b> 24 VDC, 4 A ohmic (inductive in case of appropriate protective wiring)

Fuse rating of the safety contacts:	4 A slow blow
Switching capacity of the signalling outputs:	<b>L54 / L84:</b> max. 50 mA <b>Muting indicators LA1 / LA2:</b> 24 V / max. 0.5 A; min. 100 mA
Fuse rating of the signalling outputs:	<b>LA1 / LA2:</b> F2, F3 = T 0.5 A
Utilisation category to EN 60947-5-1:	DC-13: EN 60947-5-1
Dimensions (H/W/D):	100 mm x 45 mm x 121 mm

The data specified in this manual is applicable when the component is operated with rated operating voltage  $U_e \pm 0\%$ .

## 2.5 Safety classification

Standards:	EN ISO 13849-1, IEC 61508, EN 60947-5-1, DIN EN 61496-1 part A.7.4
PL:	up to e
Control category:	up to 4
DC:	Stop 0: 99% (high)
CCF:	> 65 points
SIL:	up to 3
Service life:	20 years
$B_{10d}$ value (for one channel):	Low voltages range 20%: 20,000,000 40%: 7,500,000 60%: 2,500,000 80%: 1,000,000 Maximum load 100%: 400,000

$$MTTF_d = \frac{B_{10d}}{0,1 \times n_{op}} \quad n_{op} = \frac{d_{op} \times h_{op} \times 3600 \text{ s/h}}{t_{cycle}}$$

For an average annual demand rate of  $n_{op} = 126,720$  cycles per year, Performance Level PL e can be obtained at maximum load.

$n_{op}$  = average number of activations per year  
 $d_{op}$  = average number of operating days per year  
 $h_{op}$  = average number of operating hours per day  
 $t_{cycle}$  = average demand rate of the safety function in s  
(e.g. 4 × per hour = 1 × per 15 min. = 900 s)

(Specifications can vary depending on the application-specific parameters  $h_{op}$ ,  $d_{op}$  and  $t_{cycle}$  as well as the load.)

## 3 Mounting

### 3.1 General mounting instructions

Mounting: snaps onto standard DIN rails to EN 60715.

Snap the bottom of the enclosure slightly tilted forwards in the DIN rail and push up until it latches in position.

### 3.2 Dimensions

All measurements in mm.

Device dimensions (H/W/D): 100 x 45 x 121 mm  
with plugged-in terminals: 120 x 45 x 121 mm

## 4 Electrical connection

### 4.1 General information for electrical connection



The electrical connection may only be carried out by authorised personnel in a de-energised condition.

Wiring examples: see appendix

## 5 Operating principle and settings

### 5.1 LED functions

- K1: Status reset
- K2: Status channel 1
- K3: Status channel 2
- K4: Status lamp monitoring channel 1
- K5: Status monitoring channel 2
- LA: Status LA1-LA2
- $U_B$ : Status operating voltage (LED is on, when the operating voltage on the terminals A1-A2 is ON)
- $U_i$ : Status internal operating voltage (LED is on, when the operating voltage on the terminals A1-A2 is ON and the fuse has not been triggered)

### 5.2 Description of the terminals

Voltages:	A1	24 VDC
	A2	0 VDC
Inputs:	S11-S12	Input channel S1-S3 (+)
	S12-S13	Input channel S1-S3 (-)
	S21-S22	Input channel S2-S4 (+)
	X1-MR	Master reset
Outputs:	13-14	First safety enabling circuit (stop 0)
	23-24	Second safety enabling circuit (stop 0)
	X13-14	Bridging first enabling circuit
	X23-24	Bridging second enabling circuit
	LA1-LA2	Muting lamp
Start:	X1-X2	Feedback circuit
Signalling outputs:	L54	Signalling output
	L84	Signalling output

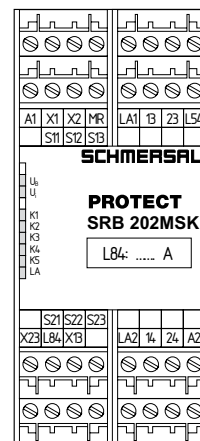

Fig. 1: SRB 202MSK

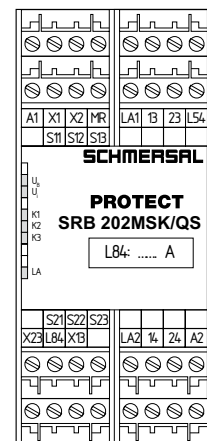

Fig. 2: SRB 202MSK/QS

### 5.3 Set-up instructions

The signalling output L84 is used to signal a defective muting lamp. To set this signalling output, the following steps must be executed:

- Prior to switching the supply voltage (24 VDC) on, check the proper connection of the SRB 202MSK / SRB 202MSK/QS and connect a muting lamp to the outputs LA1 and LA2 (min. 100 mA, max. 500 mA).
- The enclosure must be opened to set the signalling output L84. To open the front cover, insert a slot screwdriver in the top and bottom cover notch and gently lift it (Fig. 3 and 4). When the front cover is open, the electrostatic discharge requirements must be respected and observed. After the setting, the front cover must be fitted back in position.
- Bring the SRB 202MSK / SRB 202MSK/QS in muting condition (actuate the sensors S1 and S2 within the timeframe).
- Check if the muting lamp is on.
- Connect a voltmeter to output L84 and the 0V potential and turn the lamp trimmer R1 (Fig. 5) until the signal condition of output L84 changes from 24V to 0V.
- Remove the muting lamp at the outputs LA1 and LA2. The signal condition of output L84 changes to 24 V. Reconnect the muting lamp.
- The set lamp current must be entered on the front cover.

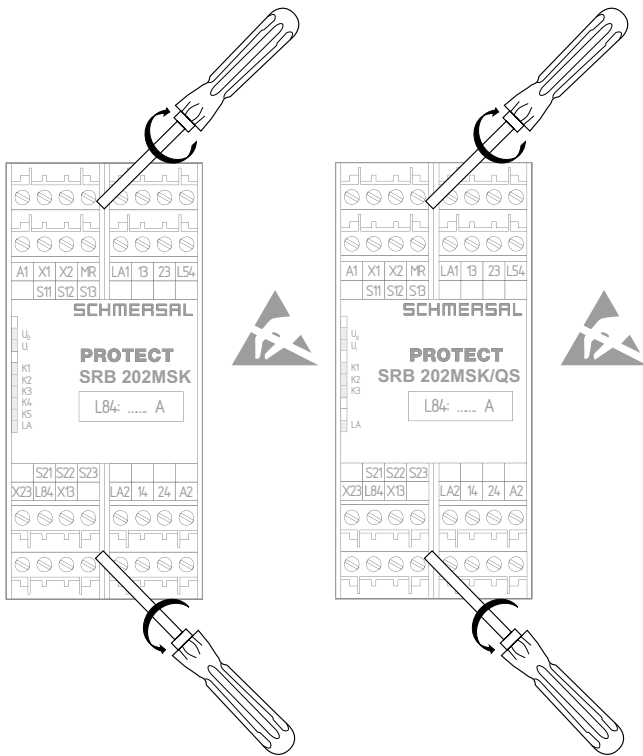

Fig. 3: SRB 202MSK

Fig. 4: SRB 202MSK/QS



Fig. 5

## 6 Set-up and maintenance

### 6.1 Functional testing

The safety function of the safety-monitoring module must be tested. The following conditions must be previously checked and met:

1. Correct fixing
2. Check the integrity of the cable entry and connections
3. Check the safety-monitoring module's enclosure for damage.
4. Check the electrical function of the connected sensors and their influence on the safety-monitoring module and the downstream actuators

### 6.2 Maintenance

A regular visual inspection and functional test, including the following steps, is recommended:

1. Check the correct fixing of the safety-monitoring module
2. Check the cable for damages
3. Check electrical function

**Damaged or defective components must be replaced.**

## 7 Disassembly and disposal

### 7.1 Disassembly

The safety-monitoring module must be disassembled in a de-energised condition only.

### 7.2 Disposal

The safety-monitoring module must be disposed of in an appropriate manner in accordance with the national prescriptions and legislations.

8 Appendix

8.1 Wiring examples

Dual-channel control, shown for 2 muting sensors and an external master reset button (R) (Fig. 6 and 7)

- Relay outputs: 2-channel control, suitable for increase incapacity or number of contacts by means of contactors or relays with positive-guided contacts.
- The control system recognises wire-breakage and earth faults in the monitoring circuit.
- Only SRB 202MSK/QS: Cross-wire shorts between the monitoring circuits are detected.
- Electronic fuse F1: 1.25 A
- (R) = Feedback circuit

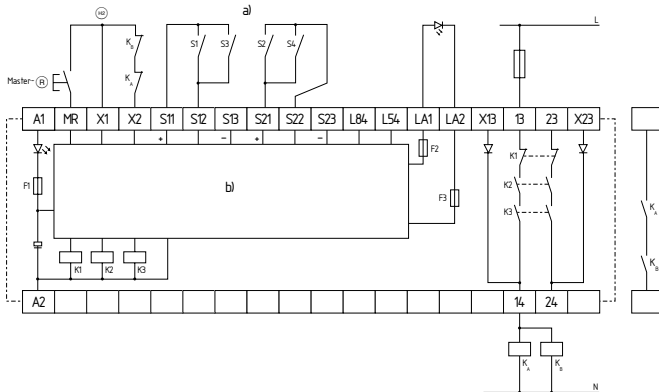

Fig. 6: SRB 202MSK  
a) Muting sensors  
b) Logic and lamp monitoring

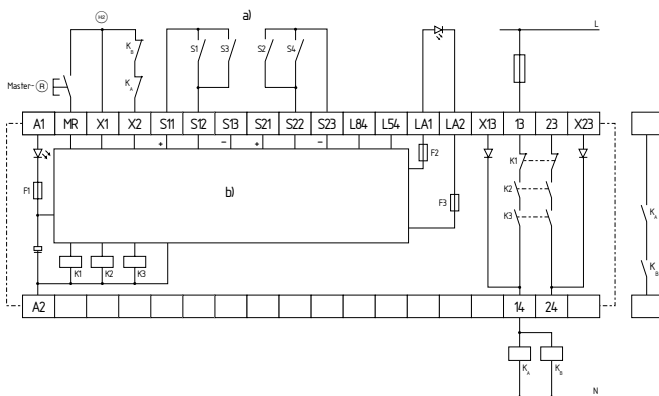

Fig. 7: SRB 202MSK/QS  
a) Muting sensors  
b) Logic and lamp monitoring

Wiring example AOPD\* with relay outputs or semi-conductor outputs (Fig. 8 to 13)

\* Active Optoelectronic Protective Device, e.g. safety light grids etc., formerly also known as ESD (= electro-sensitive safety device)

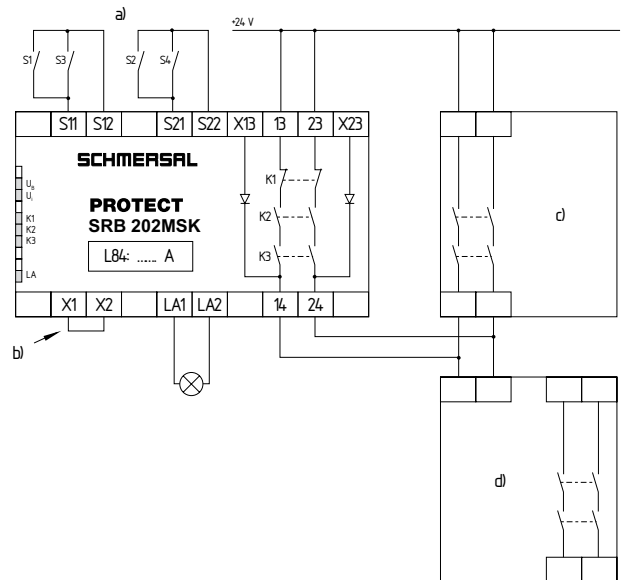

Fig. 8: SRB 202MSK  
a) Muting sensors,  
b) Bridge;  
c) AOPD (relay outputs);  
d) Elan safety relay

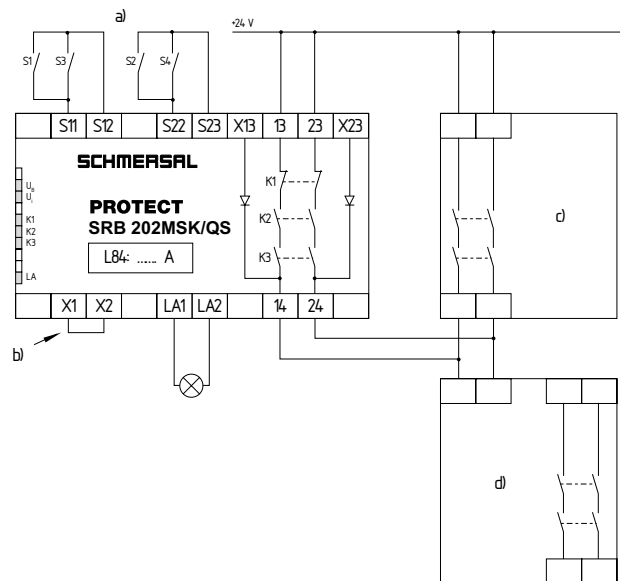

Fig. 9: SRB 202MSK/QS  
a) Muting sensors,  
b) Bridge;  
c) AOPD (relay outputs);  
d) Elan safety relay

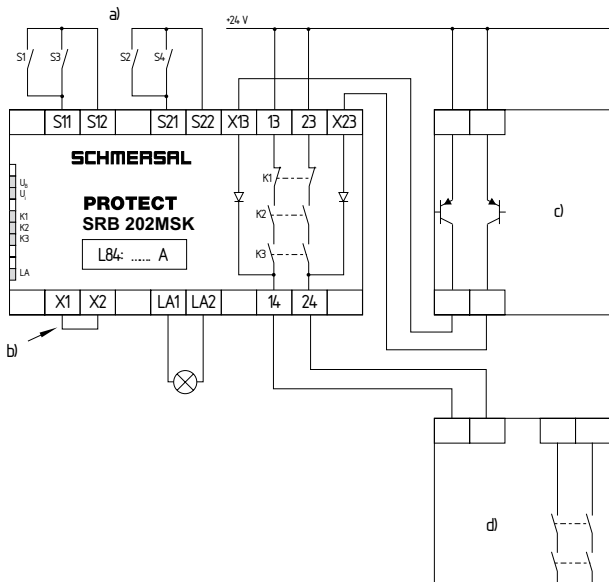

Fig. 10: SRB 202MSK

- a) Muting sensors,
- b) Bridge;
- c) AOPD (semi-conductor outputs);
- d) Elan safety relay

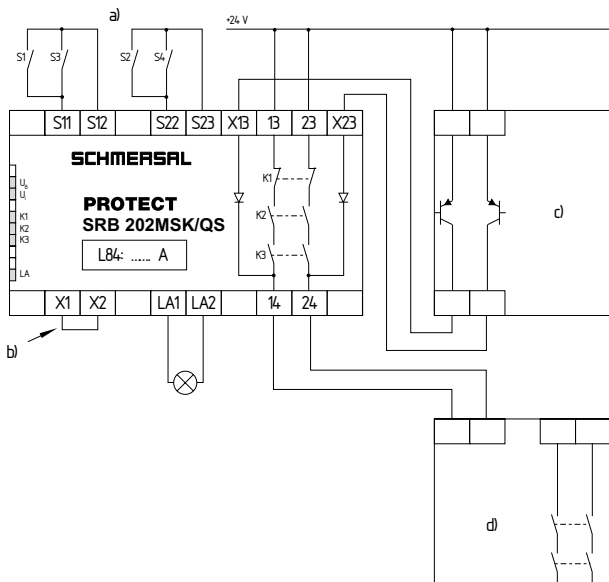

Fig. 11: SRB 202MSK/QS

- a) Muting sensors,
- b) Bridge;
- c) AOPD (semi-conductor outputs);
- d) Elan safety relay

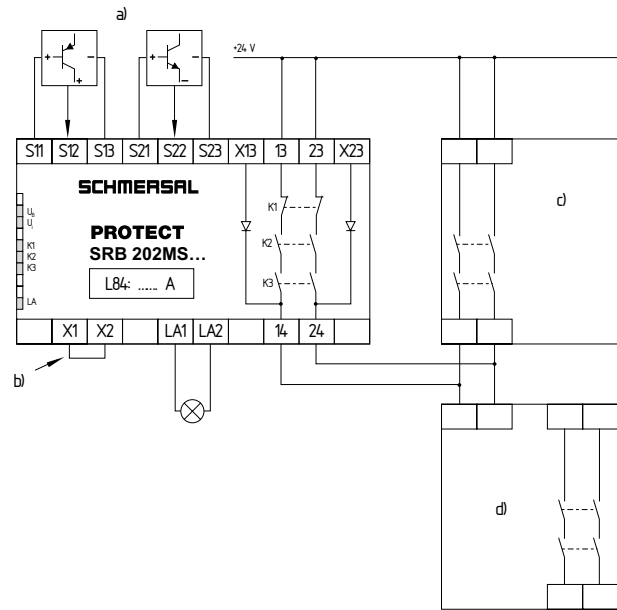

Fig. 12: SRB 202MSK or SRB 202MSK/QS

- a) Muting sensors,
- b) Bridge;
- c) AOPD (relay outputs);
- d) Elan safety relay

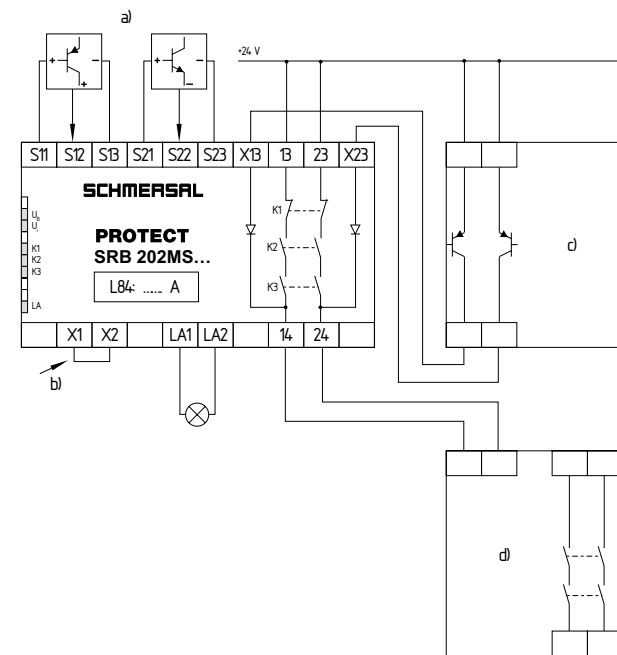

Fig. 13: SRB 202MSK or SRB 202MSK/QS

- a) Muting sensors,
- b) Bridge;
- c) AOPD (semi-conductor outputs);
- d) Elan safety relay

### 8.2 Sensor configuration

#### Dual-channel muting circuit (Fig. 14)

- Wire breakage and earth leakage in the control circuits are detected.
- The SRB 202MSK/QS detects cross-wire shorts between the muting sensors.
- With external reset button
- The reset button is integrated in the feedback circuit in series.
- If the reset button is not required, establish a bridge.
- Control category 4 – PL “e” to DIN EN ISO 13849-1 possible

#### Master reset (Fig. 15)

- The master reset pushbutton must be connected to terminal X1-MR.
- The master reset enables resetting a locked safety-monitoring module. The input MR reacts on a rising edge.

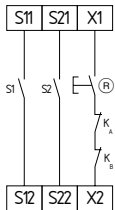

Fig. 14

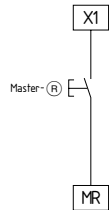

Fig. 15

### 8.3 Actuator configuration

#### Dual-channel control with feedback circuit (Fig. 16)

- Suitable for increase in capacity or number of contacts by means of contactors or relays with positive-guided contacts.
- $\text{Ⓜ}$  = Feedback circuit:  
if the feedback circuit is not required, establish a bridge.

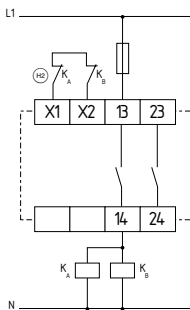

Fig. 16

### 8.4 Flow diagram

see Fig. 17

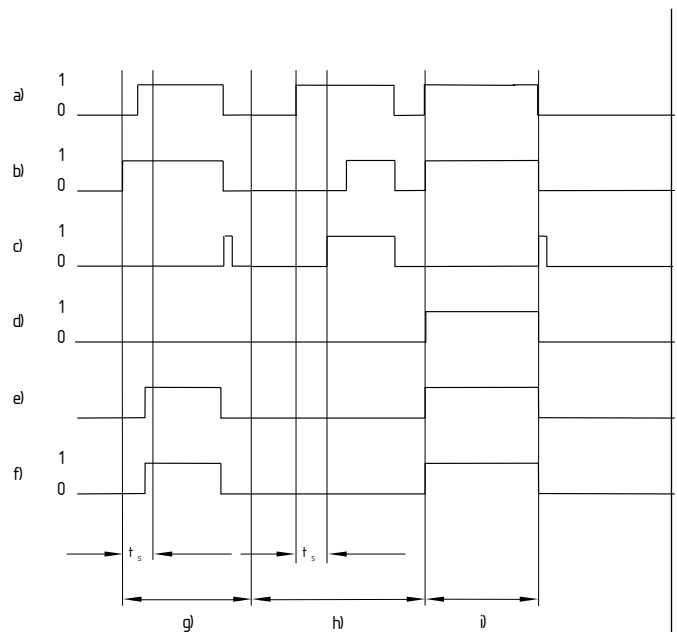





Fig. 17

- a) Bypass switch S1;
- b) Bypass switch S2;
- c) Simultaneity indication L54;
- d) Signalling output L84 (lamp current);
- e) Lamp current LA1-LA2;
- f) Output contacts 13-14 / 23-24 potential-free;
- g) uninterrupted workcycle;
- h) Synchronous actuation fault  $t_s > 2.5$  s
- i) Muting indicator defective

8.5 EC Declaration of conformity

	
<h2>EC Declaration of conformity</h2>	
Translation of the original declaration of conformity	Elan Schaltelemente GmbH & Co. KG Im Ostpark 2 · 35435 Wettenberg Germany Internet: www.elan.de
We hereby certify that the hereafter described safety components both in its basic design and construction conforms to the applicable European Directives.	
<b>Name of the safety component:</b>	SRB 202MSK / SRB 202MSK/QS
<b>Description of the safety component:</b>	Safety-monitoring module for muting circuits
<b>Harmonised EC-Directives:</b>	2006/42/EC EC-Machinery Directive 2004/108/EC EMC-Directive
<b>Person authorized for the compilation of the technical documentation:</b>	Ulrich Loss Möddinghofe 30 42279 Wuppertal
<b>Notified body, which approved the full quality assurance system, referred to in Appendix X, 2006/42/EC:</b>	TÜV Rheinland Industrie Service GmbH Alboinstraße 56 12103 Berlin ID n°: 0035
<b>Place and date of issue:</b>	Wuppertal, October 6, 2009
SRB202MSK-B-EN	
	Authorised signature Heinz Schmersal Managing Director
	



**Note**

The currently valid declaration of conformity can be downloaded from the internet at [www.schmersal.net](http://www.schmersal.net).

**Elan Schaltelemente GmbH & Co. KG**  
Im Ostpark 2, D - 35435 Wettenberg  
Postfach 1109, D - 35429 Wettenberg

Telefon: +49 (0)641 9848-0  
Telefax: +49 (0)641 9848-420  
E-Mail: [info-elan@schmersal.com](mailto:info-elan@schmersal.com)  
Internet: [www.elan.de](http://www.elan.de)